

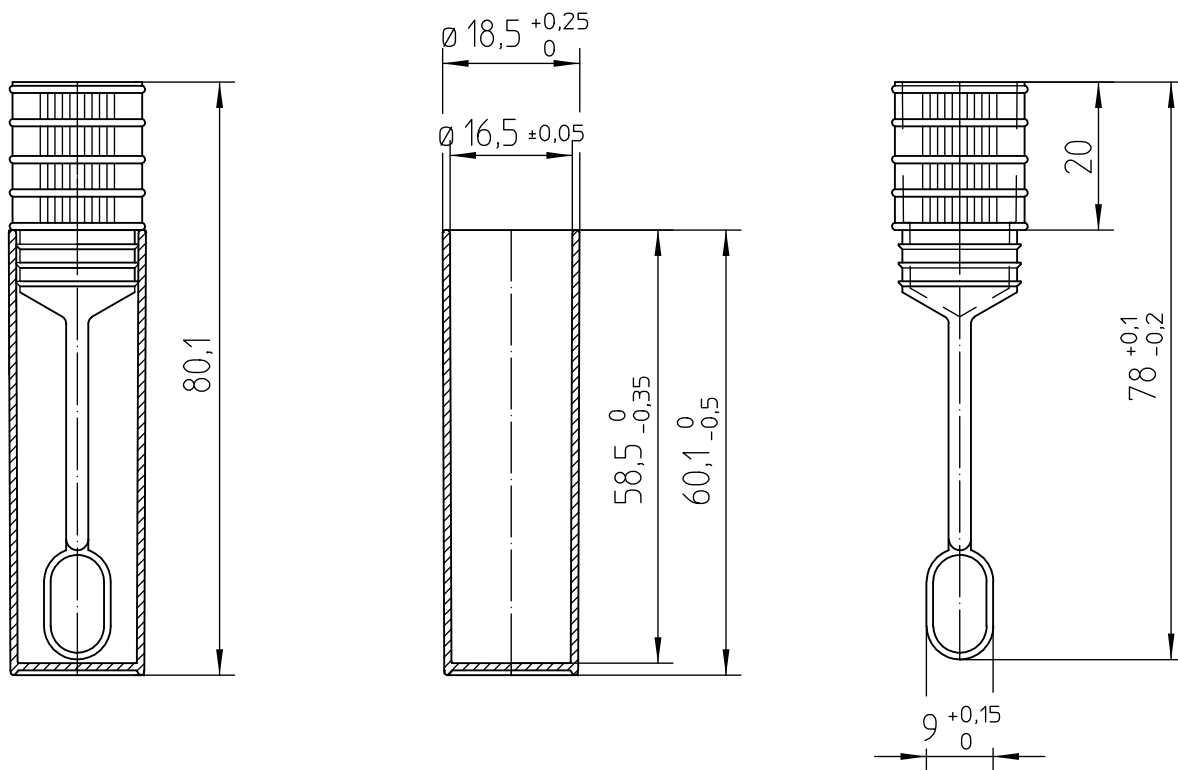

Valid for Item-No.: 430102



Only layout change, no design change of the product.
 Prior drawing No. AC-430102/ Rev 01/ October 7, 2005

"All dimensions in mm"

Customer drawing subject to change without notice!

Prior Issue	Drawn	Approved	Released	CONFIDENTIAL: Information contained in this document or drawing is confidential and proprietary to Greiner Bio-One GmbH. This document may not be reproduced for any reason without written permission from Greiner Bio-One GmbH. All rights of design, invention, and copyright are reserved.
Revision	Date 2011/02/11	Date 2011/02/11	Date 2011/02/11	
Date	Name falter	Name falter	Name sonntag	